

## DIN W72×H36mm, W96×H48mm, Digital Multi Panel Meter

### ■ Features

- Super version of panel meter
- Various output options (Default: Indicator)  
RS485 Communication output, Low speed serial output, Current (4-20mA), BCD output, NPN/PNP open collector output, Relay output
- Max. measuring input specification : 500VDC, 500VAC, 5ADC, 5ACA
- Max. display range: -1999 to 9999
- High/Low scale function
- **AC frequency measurement function: 0.1 to 9999Hz**
- Various functions: Monitoring function for max. and min. display value function, display cycle delay function, **Zero function**, High display correction function, **Current output scale function**
- Wide range of power supply: 12-24VDC, 100-240VAC 50/60Hz



**⚠ Please read "Caution for your safety" in operation manual before using.**



### ■ Ordering Information

**MT 4 W - DV - 4 N**

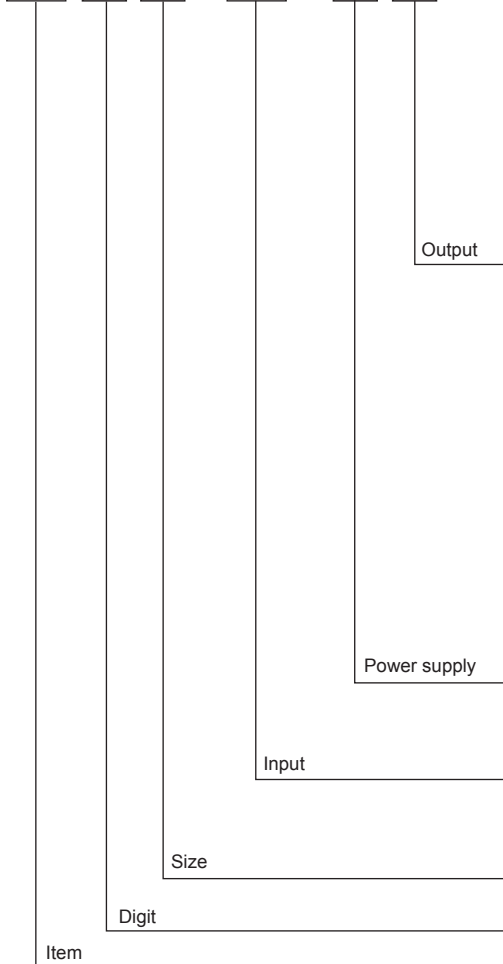





Y Type	
N	Indicator (Without output function)
0	Relay output
1	NPN open collector output
2	PNP open collector output
3 <sup>※1</sup>	Relay output (Low out)+Transmission output (DC4-20mA)
4 <sup>※1</sup>	Relay output (Low out)+RS485 communication output
5	BCD dynamic output
6	Low speed serial output
※Output (0 to 6): Option	
W Type	
N	Indication type (No output function)
0	Relay output+Transmission output (DC4-20mA)
1	Relay output
2	NPN open collector output+BCD dynamic output
3	PNP open collector output+BCD dynamic output
4	NPN open collector output+Transmission output (DC4-20mA)
5	PNP open collector output+Transmission output (DC4-20mA)
6	NPN open collector output+Low speed serial output
7	PNP open collector output+Low speed serial output
8	NPN open collector output+RS485 output
9	PNP open collector output+RS485 output
※Output (0 to 9): Option	
1 <sup>※2</sup>	12-24VDC
4	100-240VAC 50/60Hz
DV	DC voltage
DA	DC current
AV	AC voltage
AA	AC current
Y	DIN W72×H36mm
W	DIN W96×H48mm
4	9999 (4digit)
MT	Multi meter

- (A) Photoelectric Sensors
- (B) Fiber Optic Sensors
- (C) Door/Area Sensors
- (D) Proximity Sensors
- (E) Pressure Sensors
- (F) Rotary Encoders
- (G) Connectors/ Sockets
- (H) Temperature Controllers
- (I) SSRs / Power Controllers
- (J) Counters
- (K) Timers
- (L) Panel Meters
- (M) Tacho / Speed / Pulse Meters
- (N) Display Units
- (O) Sensor Controllers
- (P) Switching Mode Power Supplies
- (Q) Stepper Motors & Drivers & Controllers
- (R) Graphic/ Logic Panels
- (S) Field Network Devices
- (T) Software

※1: Only L5t (preset output mode) setting is available in MT4Y-□-43 (Relay output (Low out)+Transmission output (DC4-20mA)) and MT4Y-□-43 (Relay output (Low out)+Transmission output (DC4-20mA)) models.  
 ※2: Only for MT4W.  
 ※To measure the current over DC 5A, please select DV type because the shunt should be used.  
 ※In case of selecting frequency display, no output will be provided even if it is output support models. (Main output, Sub output and RS485 output)

# MT4Y/MT4W Series

## Specifications

Series	MT4Y-DV-4□ MT4Y-DA-4□	MT4Y-AV-4□ MT4Y-AA-4□	MT4W-DV-4□ MT4W-DA-4□	MT4W-AV-4□ MT4W-AA-4□	MT4W-DV-1□ MT4W-DA-1□	MT4W-AV-1□ MT4W-AA-1□
Measurement input	DC voltage, current	AC voltage, current, Frequency	DC voltage, current	AC voltage, current, Frequency	DC voltage, current	AC voltage, current, Frequency
Power supply	100-240VAC 50/60Hz (Allowable voltage range: 90 to 110%)				12-24VDC (Allowable voltage range: 90 to 110%)	
Power consumption	5VA				5W	
Display method	7Segment LED display (red) (Character height: 14.2mm)					
Display accuracy	<ul style="list-style-type: none"> <li>• 23°C±5°C - DC Type: F.S. ±0.1% rdg±2digit / AC Type: F.S. ±0.3% rdg±3digit</li> <li>DC/AC Type F.S. +0.3% rdg +3digit max. only for 5A terminal.</li> <li>• -10°C to 50°C - DC/AC Type: F.S.±0.5% rdg±3digit</li> </ul>					
Max. allowable input	110% F.S for each measured input range					
A/D conversion method	Practical oversampling using successive approximation ADC					
Sampling cycle	DC type: 50ms, AC type: 16.6ms					
Max. indication range	-1999 to 9999 (4digit)					
Preset output	<ul style="list-style-type: none"> <li>• Relay output - Contact capacity: 250VAC 3A, 30VDC 3A / Contact composition: N.O (1a)</li> <li>• NPN/PNP Open collector output - 12-24VDC ±2V 50mA Max. (Resistive load)</li> </ul>					
Sub output (Transmission output)	<ul style="list-style-type: none"> <li>• RS485 communication output - Baud rate: 1200/2400/4800/9600, Communication method: 2-wire half duplex, Synchronous method: Asynchronous method, Protocol: Modbus type</li> <li>• Serial/BCD output - NPN Open collector output: 12-24VDC Max. 50mA (Resistive load)</li> <li>• DC4-20mA output - Resolution: 12,000 division (Load resistance max. 600Ω)</li> </ul>					
AC measuring function※1	Selectable RMS or AVG					
Frequency measurement function※1	Measurement range: 0.100 to 9999Hz (Variable by decimal point position)					
Hold function※2	Includes (External hold function)					
Insulation resistance	Min. 100MΩ (at 500VDC megger) between external terminal and case					
Dielectric strength	2,000VAC for 1minute between external terminal and case					
Noise strength	±2kV the square wave noise (pulse width: 1μs) by the noise simulator					
Vibration	Mechanical	0.75mm amplitude at frequency of 10 to 55Hz (for 1 min.) in each X, Y, Z direction for 2 hours				
	Malfunction	0.5mm amplitude at frequency of 10 to 55Hz (for 1 min.) in each X, Y, Z direction for 10 min.				
Shock	Mechanical	100m/s <sup>2</sup> (approx. 10G) in each X, Y, Z direction for 3 times				
	Malfunction	300m/s <sup>2</sup> (approx. 30G) in each X, Y, Z direction for 3 times				
Relay life cycle	Mechanical	Min. 20,000,000 operations				
	Malfunction	Min. 100,000 operations (250VAC 3A Load current)				
Environ-ment	Ambient temperature	-10 to 50°C, storage: -20 to 60°C				
	Ambient humidity	35 to 85%RH, storage: 35 to 85%RH				
Insulation type	Double insulation or reinforced insulation (Mark:  , dielectric strength between the measuring input part and the power part: 1kV)					
Approval	 					
Unit weight	Approx. 134g			Approx. 211g		

※1: AC measuring function, and frequency measuring function are only for AC measuring input type.

If only frequency input the AC type (display method of measuring input) which option is in MT4W, MT4W will operate the only indicator type.

※2: MT4Y-□-4N model has no hold function.

※Environment resistance is rated at no freezing or condensation.

## Unit Description



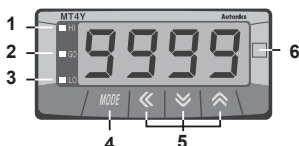

### • MT4Y Series

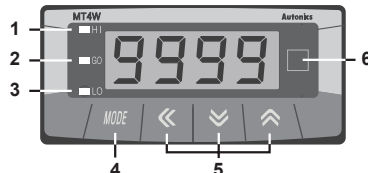

1. HI: High output indication of preset
2. GO: GO output indication of preset
3. LO: Low output indication of preset

### • MT4W Series



4.  key: Mode Key
5. : Moves digit, enters parameter mode,  : changes SV
6. Unit label part

※There is no 1, 2, 3 on a display panel of MT4Y-□-4N, 45, 46 and MT4W-□-4N.

※In MT4Y-□-□3, □4, OUT is used for Go output display and there is no 1, 3 in display panel.

## ■ Connections

### ◎ Measuring input connection of MT4Y Series

#### ● MT4Y-DV-4□

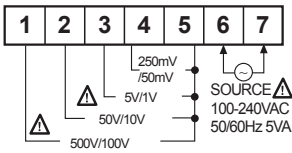

#### ● MT4Y-AV-4□

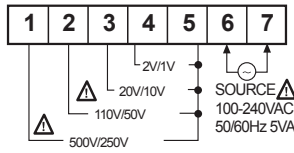

#### ● MT4Y-DA-4□

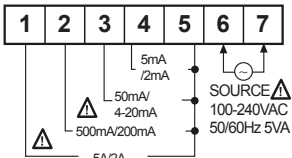

#### ● MT4Y-AA-4□

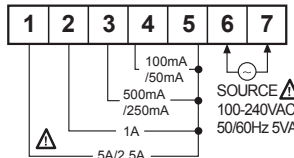

### ◎ Output terminal of connection of MT4Y Series

#### ● MT4Y-□-4N (Indicator)

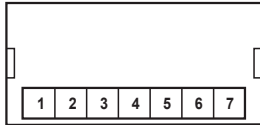

#### ● MT4Y-□-40

(Triple relay output)

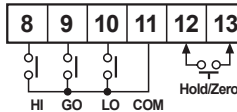

#### ● MT4Y-□-41

(Triple NPN O.C output)

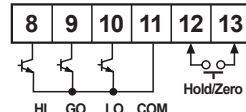

#### ● MT4Y-□-42

(Triple PNP O.C output)

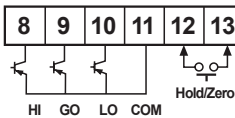

#### ● MT4Y-□-43

(Relay output+Transmission output)

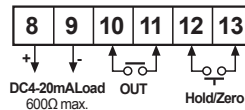

#### ● MT4Y-□-44

(Relay+RS485 communication output)

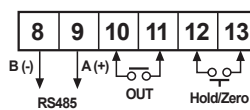

#### ● MT4Y-□-45

(BCD Dynamic output)

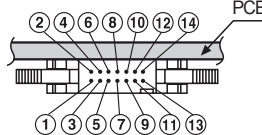
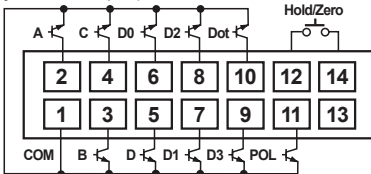

#### ● MT4Y-□-46 (Low speed serial output)

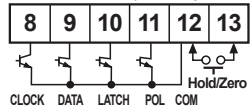

※POL: When a display value is "-", the signal of "-" will be outputted.

※Hirose connector pin header model of the unit: HIF3BA-14PA-2.54DS

※Contact Hirose Electric to purchase socket and wires of Hirose connector.

[Socket: HIF3BA-14D-2.54R]

### ◎ Measuring input connection of MT4W Series

#### ● MT4W-DV-□□

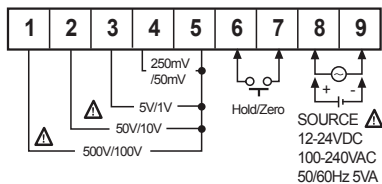

#### ● MT4W-AV-□□

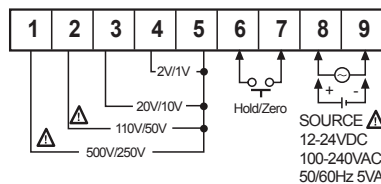

#### ● MT4W-DA-□□

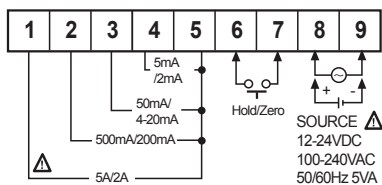

#### ● MT4W-AA-□□

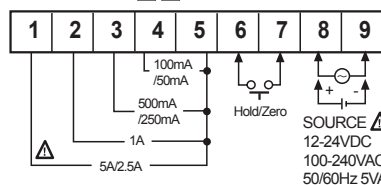

(A) Photoelectric Sensors

(B) Fiber Optic Sensors

(C) Door/Area Sensors

(D) Proximity Sensors

(E) Pressure Sensors

(F) Rotary Encoders

(G) Connectors/ Sockets

(H) Temperature Controllers

(I) SSRs / Power Controllers

(J) Counters

(K) Timers

(L) Panel Meters

(M) Tacho / Speed / Pulse Meters

(N) Display Units

(O) Sensor Controllers

(P) Switching Mode Power Supplies

(Q) Stepper Motors & Drivers & Controllers

(R) Graphic/ Logic Panels

(S) Field Network Devices

(T) Software

# MT4Y/MT4W Series

## ◎ Output terminal connection of MT4W Series

- **MT4W-□-□0** (Triple relay output +Transmission output)

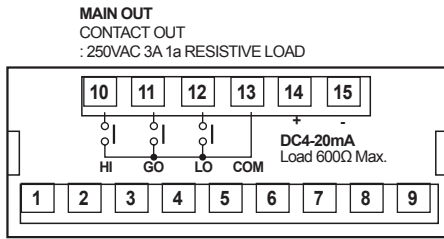

- **MT4W-□-□1** (Triple relay output)

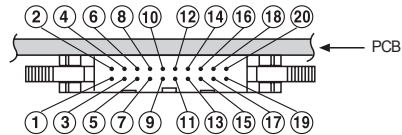
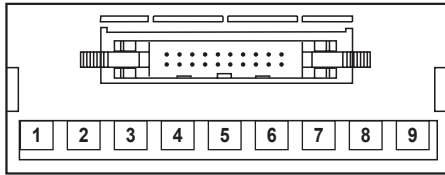
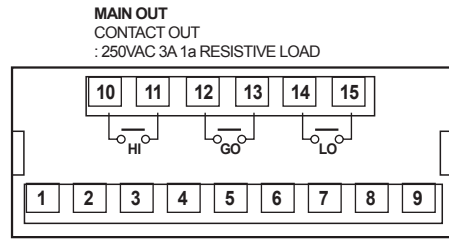

※Hirose connector pin header model of the unit: HIF3BA-20PA-2.54DS  
 ※Contact Hirose Electric to purchase socket and wires of Hirose connector.  
 [Socket: HIF3BA-20D-2.54R]

- **MT4W-□-□2 / MT4W-□-□3** (Triple NPN/PNP open collector output+BCD output)

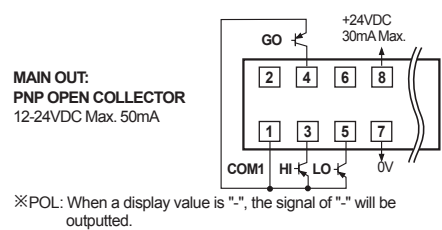
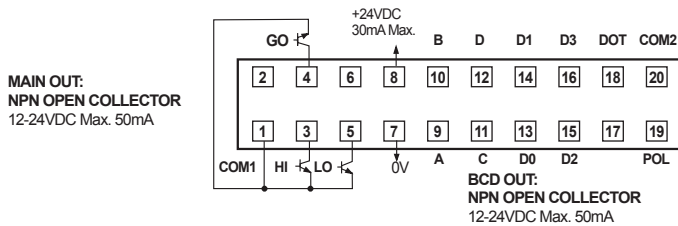

- **MT4W-□-□4 / MT4W-□-□5** (Triple NPN/PNP open collector output+Transmission output)

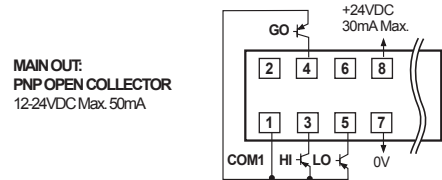
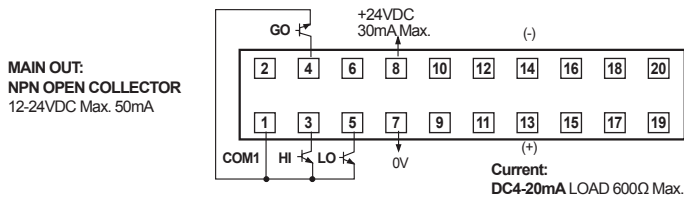

- **MT4W-□-□6 / MT4W-□-□7** (Triple NPN/PNP open collector output+Low speed serial output)

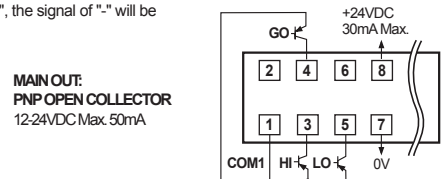
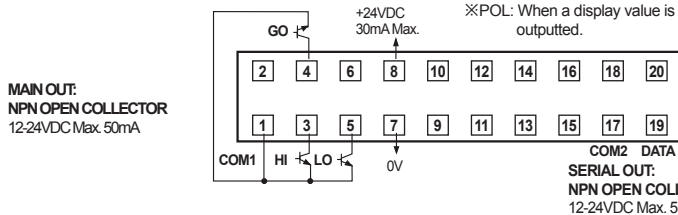

- **MT4W-□-□8 / MT4W-□-□9** (Triple NPN/PNP open collector output+RS485 output)

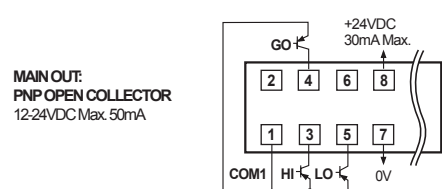
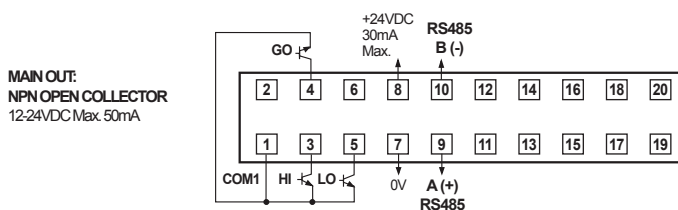

## ■ Dimensions

(unit: mm)

### ● MT4Y-□-4N, 45, 46

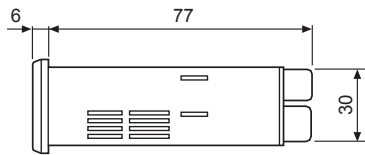
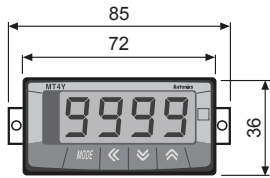

<MT4Y-□-4N, 40 to 44, 46>

### ● Panel cut-out

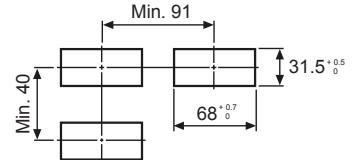

### ● MT4Y-□-43, 44

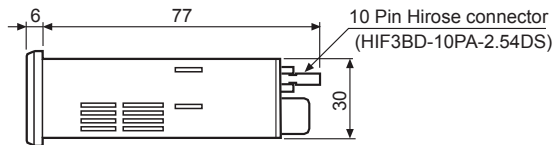

<MT4Y-□-45>

### ● MT4Y-□-40, 41, 42



### ● MT4W-□-□N (Indicator)

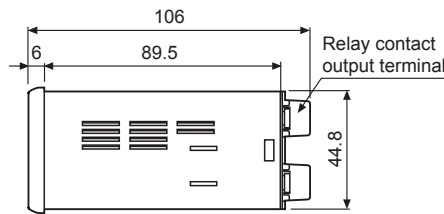
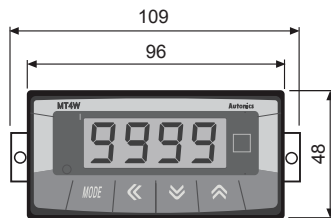

※ There is no Relay output terminal block in indication type.

< MT4W-□-□N, MT4W-□-□0, □1 >

### ● Panel cut-out

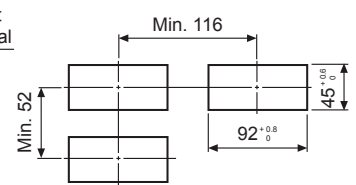

### ● MT4W-□-□0 to □9

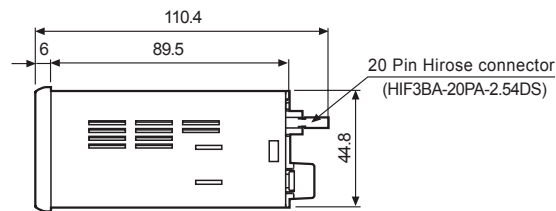

< MT4W-□-□2 to □9 >

## ■ Parameter Setting

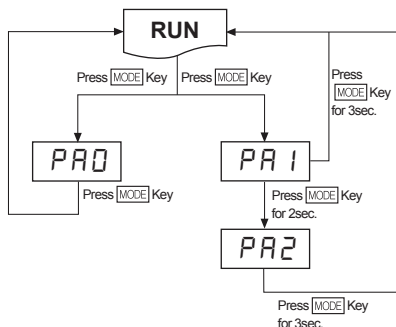

※ Press **[MODE]** key in **RUN** status, it will advance to **[PA0]** (Parameter 0) group.

※ Press **[MODE]** key for 2 sec. in **RUN** mode, **[PA1]** is displayed.

※ Press **[MODE]** key for 4 sec. in **RUN** mode, **[PA2]** is displayed after **[PA1]**.

When pressing **[MODE]** key continually, it stops displaying at **[PA2]**.

※ It is advanced to current display parameter releasing **[MODE]** key at **[PA1]** or **[PA2]**.

※ Press **[MODE]** key for 3 sec., it is returned to **RUN** at any position.

※ If any key is not touched for 60 sec. in each parameter, it returns to **RUN** mode.

※ After return to **RUN** mode, press **[MODE]** key within 2 sec., it returns to previous parameter. (Refer to the below descriptions for set parameter.)

※ It cannot advance to **[PA0]** when preset output operation mode of **[PA2]** is **[pFF]**.

(A)	Photoelectric Sensors
(B)	Fiber Optic Sensors
(C)	Door/Area Sensors
(D)	Proximity Sensors
(E)	Pressure Sensors
(F)	Rotary Encoders
(G)	Connectors/ Sockets
(H)	Temperature Controllers
(I)	SSRs / Power Controllers
(J)	Counters
(K)	Timers
(L)	Panel Meters
(M)	Tacho / Speed / Pulse Meters
(N)	Display Units
(O)	Sensor Controllers
(P)	Switching Mode Power Supplies
(Q)	Stepper Motors & Drivers & Controllers
(R)	Graphic/ Logic Panels
(S)	Field Network Devices
(T)	Software

# MT4Y/MT4W Series

## Parameter 1 Group

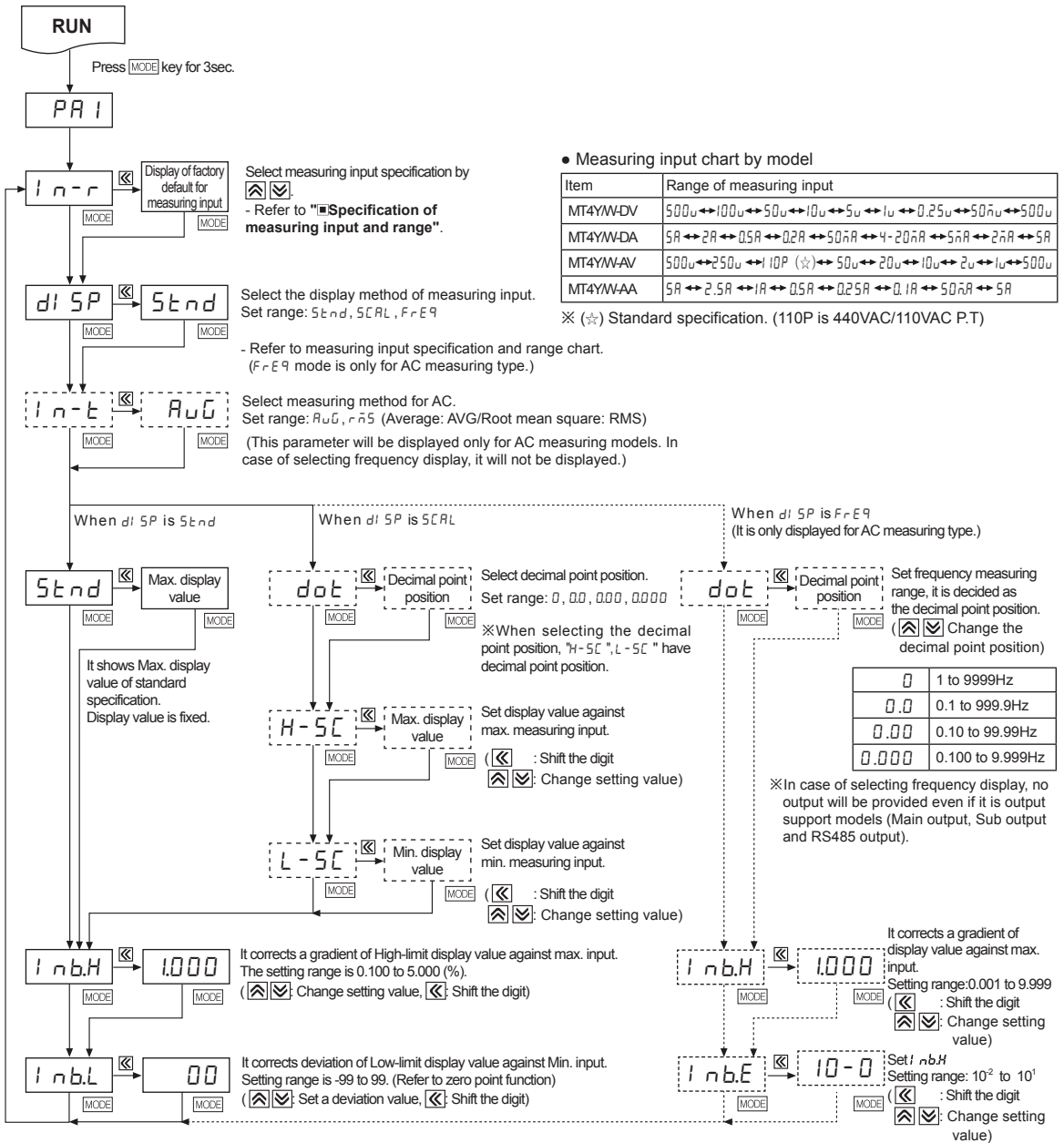

※After setting each mode, press [MODE] key for 2 sec. to return to RUN.

※If any key is untouched for 60sec. after advance to Parameter, it will return to RUN.

## Factory defaults

Parameter	MT4Y/W-DV	MT4Y/W-DA	MT4Y/W-AV	MT4Y/W-AA	Parameter	MT4Y/W-DV	MT4Y/W-DA	MT4Y/W-AV	MT4Y/W-AA
<i>In-r</i>	500 $\mu$	5A	500 $\mu$	5A	<i>InbH</i>	1.000	1.000	1.000	1.000
<i>di SP</i>	Stnd	Stnd	Stnd	Stnd	<i>InbL</i>	00	00	00	00
<i>In-t</i>	—	—	AuG	AuG	<i>dot</i>	0.0	0.000	0.0	0.000
<i>Stnd</i>	500.0	5.000	500.0	5.000	<i>InbE</i>	—	—	10-0	10-0

## Parameter 2 Group

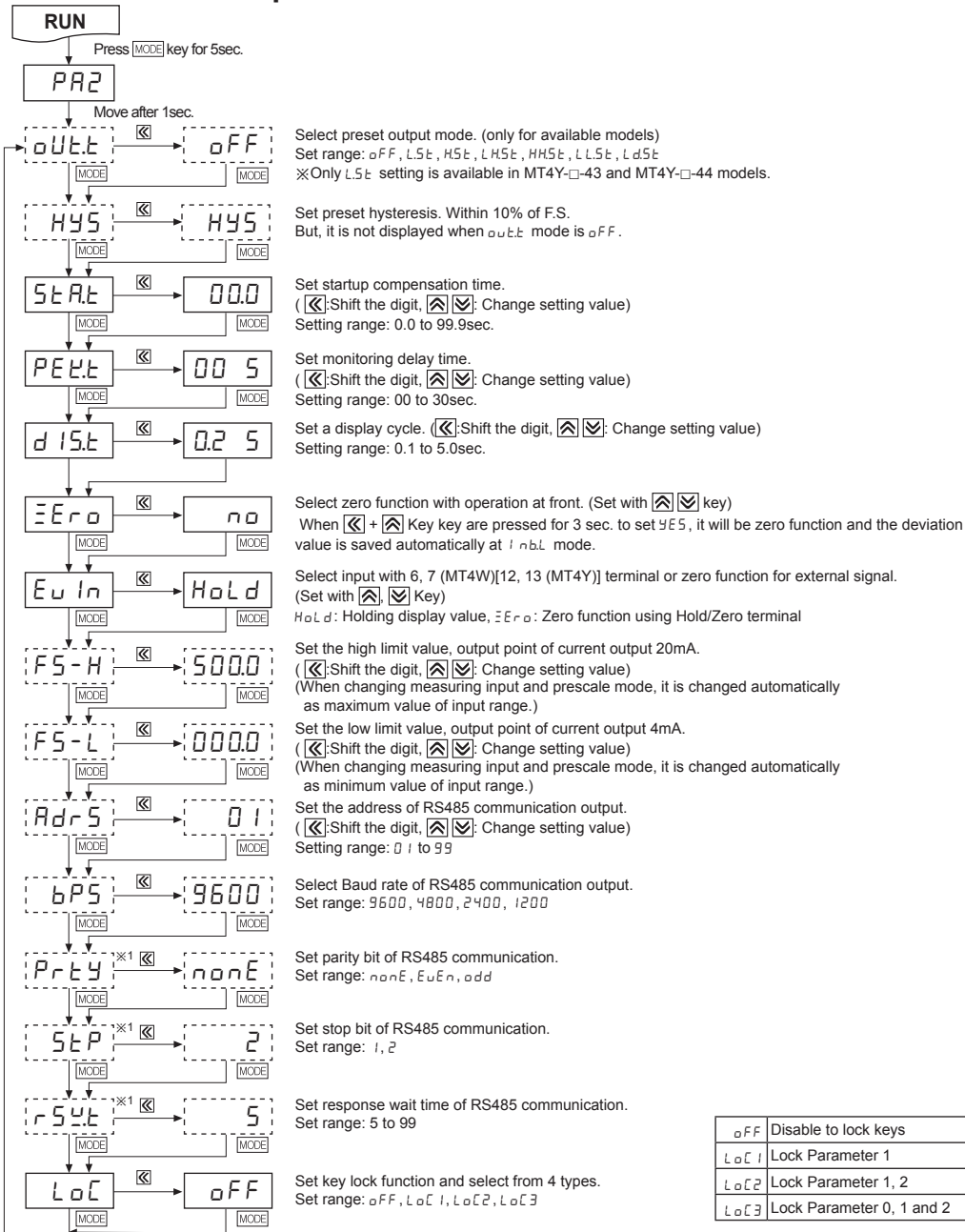

※1: These parameters do not displayed in MT4W series.

※The dotted mode is only displayed for output type.

※After setting each mode, press [MODE] key for 2 sec. to return to RUN mode.

※If any key is untouched for 60sec. after advance to PARAMETER, it will return to RUN mode.

### Factory defaults

Parameter	MT4Y/W-DV	MT4Y/W-DA	MT4Y/W-AV	MT4Y/W-AA	Parameter	MT4Y/W-DV	MT4Y/W-DA	MT4Y/W-AV	MT4Y/W-AA
oUtL	oFF	oFF	oFF	oFF	EuIn	HoLd	HoLd	HoLd	HoLd
HYS	001	001	001	001	FS-H	5000	5000	5000	5000
StArL	00.0	00.0	00.0	00.0	FS-L	0000	0000	0000	0000
PEELt	00.5	00.5	00.5	00.5	AdRS	01	01	01	01
dISL	0.2.5	0.2.5	0.2.5	0.2.5	bPS	9600	9600	9600	9600
ErrO	no	no	no	no	LoC	oFF	oFF	oFF	oFF

- (A) Photoelectric Sensors
- (B) Fiber Optic Sensors
- (C) Door/Area Sensors
- (D) Proximity Sensors
- (E) Pressure Sensors
- (F) Rotary Encoders
- (G) Connectors/ Sockets
- (H) Temperature Controllers
- (I) SSRs / Power Controllers
- (J) Counters
- (K) Timers
- (L) Panel Meters
- (M) Tacho / Speed / Pulse Meters
- (N) Display Units
- (O) Sensor Controllers
- (P) Switching Mode Power Supplies
- (Q) Stepper Motors & Drivers & Controllers
- (R) Graphic/ Logic Panels
- (S) Field Network Devices
- (T) Software

# MT4Y/MT4W Series

## Parameter 0 Group

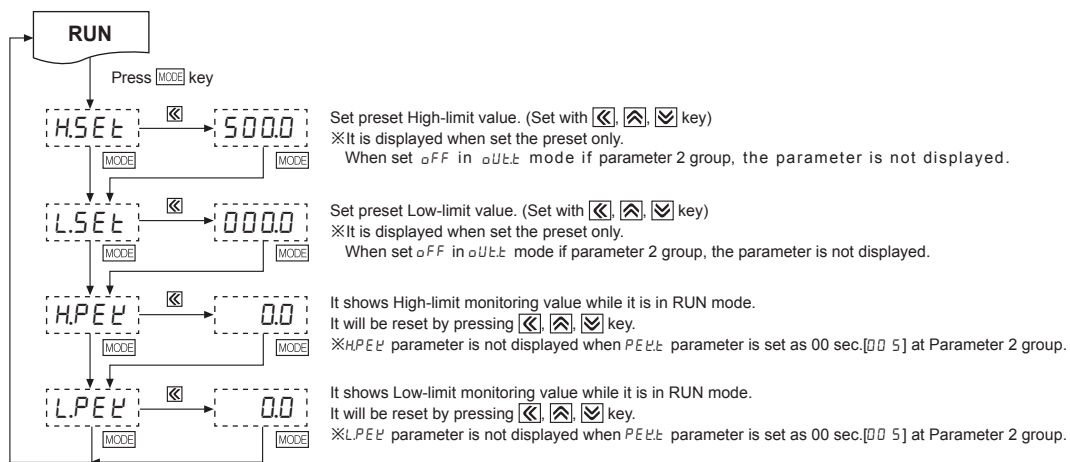

※If any key is untouched for 60sec. after advance to Parameter, it will return to **RUN** mode.

## Factory defaults

Parameter	MT4Y/W-DV	MT4Y/W-DA	MT4Y/W-AV	MT4Y/W-AA	Parameter	MT4Y/W-DV	MT4Y/W-DA	MT4Y/W-AV	MT4Y/W-AA
<b>HSEt</b>	5000	5000	5000	5000	<b>HPEt</b>	0.0	0.000	0.0	0.000
<b>LSEt</b>	0000	0000	0000	0000	<b>LPEt</b>	0.0	0.000	0.0	0.000

## Measuring Input And Range

Type	Measuring input and range		Input impedance	Display range [5tnd]	Prescale display range [5CR L]										
DC voltage	0-500V	[500u]	4.33MΩ	0.0 to 500.0	<table border="1"> <tr> <td>dolt</td> <td>Display range</td> </tr> <tr> <td>0</td> <td>-1999 to 9999</td> </tr> <tr> <td>0.0</td> <td>-199.9 to 999.9</td> </tr> <tr> <td>0.00</td> <td>-19.99 to 99.99</td> </tr> <tr> <td>0.000</td> <td>-1.999 to 9.999</td> </tr> </table> <p>(The display range is changed according to the decimal point position.)</p> <p>※Please connect proper terminal its max. input voltage is within 30 to 100% of input terminal. When it is higher than input voltage, it may cause a breakdown of terminal and over display range and the accuracy is decreased when it is connected to the terminal under 30%.</p> <p>※110P is standard specification 440V/110VAC P.T.</p>	dolt	Display range	0	-1999 to 9999	0.0	-199.9 to 999.9	0.00	-19.99 to 99.99	0.000	-1.999 to 9.999
	dolt	Display range													
	0	-1999 to 9999													
	0.0	-199.9 to 999.9													
	0.00	-19.99 to 99.99													
	0.000	-1.999 to 9.999													
	0-100V	[100u]	4.33MΩ	0.0 to 100.0											
	0-50V	[50u]	433.15kΩ	0.00 to 50.00											
0-10V	[10u]	433.15kΩ	0.00 to 10.00												
0-5V	[5u]	43.15kΩ	0.000 to 5.000												
0-1V	[1u]	43.15kΩ	0.000 to 1.000												
<b>0-250mV</b>	[0.25u]	<b>2.15kΩ</b>	<b>0.00 to 250.0</b>												
0-50mV	[50ru]	2.15kΩ	0.00 to 50.00												
DC current	0-5A	[5A]	0.01Ω	0.000 to 5.000											
	<b>0-2A</b>	[2A]	<b>0.01Ω</b>	<b>0.000 to 2.000</b>											
	0-500mA	[0.5A]	0.1Ω	0.0 to 500.0											
	<b>0-200mA</b>	[0.2A]	<b>0.1Ω</b>	<b>0.0 to 200.0</b>											
	<b>0-50mA</b>	[50ra]	<b>1.0Ω</b>	<b>0.00 to 50.00</b>											
	4-20mA	[4-20]	1.0Ω	4.00 to 20.00											
	<b>0-5mA</b>	[5ra]	<b>10.0Ω</b>	<b>0.000 to 5.000</b>											
	0-2mA	[2ra]	10.0Ω	0.000 to 2.000											
AC voltage	0-500V	[500u]	4.98MΩ	0.0 to 500.0											
	<b>0-250V</b>	[250u]	<b>4.98MΩ</b>	<b>0.0 to 250.0</b>											
	0-110V	[110P]	1.08MΩ	0.0 to 440.0											
	0-50V	[50u]	1.08MΩ	0.00 to 50.00											
	<b>0-20V</b>	[20u]	<b>200kΩ</b>	<b>0.00 to 20.00</b>											
	<b>0-10V</b>	[10u]	<b>200kΩ</b>	<b>0.00 to 10.00</b>											
	<b>0-2V</b>	[2u]	<b>20kΩ</b>	<b>0.000 to 2.000</b>											
	<b>0-1V</b>	[1u]	<b>20kΩ</b>	<b>0.000 to 1.000</b>											
AC current	0-5A	[5A]	0.01Ω	0.000 to 5.000											
	<b>0-2.5A</b>	[2.5A]	<b>0.01Ω</b>	<b>0.000 to 2.500</b>											
	0-1A	[1A]	0.05Ω	0.000 to 1.000											
	0-500mA	[0.5A]	0.1Ω	0.0 to 500.0											
	<b>0-250mA</b>	[0.25A]	<b>0.1Ω</b>	<b>0.0 to 250.0</b>											
	<b>0-100mA</b>	[0.1A]	<b>0.5Ω</b>	<b>0.0 to 100.0</b>											
0-50mA	[50ra]	0.5Ω	0.00 to 50.00												

## ■ Functions

### ◎ AC frequency measurement function [PA 1 group: $d15P$ ]

It measures input signal frequency when it is AC input. It uses fixed decimal point[PA1:  $d0E$ ], measured range can be changed by setting and measured range of decimal point position is as below chart. It is available to adjust the upper gradient at [PA 1:  $inbH$ ]and [PA 1:  $inbE$ ]. In order to measure frequency normally, input signal, over 10% F.S. of the measured range, should be supplied. Please select the proper point of

#### ① Measuring range

Decimal point position	0.000	0.00	0.0	0
Measurement range	0.100 to 9.999Hz	0.10 to 99.99Hz	0.1 to 999.9Hz	1 to 9999Hz

※Accuracy of frequency measurement:

Below 1kHz, F.S.  $\pm 0.1rdg \pm 2digit$ .

From 1kHz to 10kHz, F.S.  $\pm 0.3rdg \pm 2digit$ .

②  $inbH$ : 0.100 to 9.999 [Gradient adjustment of high value]

③  $inbE$ :  $10^{-2}$ ,  $10^{-1}$ ,  $10^0$ ,  $10^1$ [Index adjustment of  $inbH$ ]

### ◎ Zero adjustment function

#### (Deviation correction function of low limit display value)

It adjusts the display value of the optional configured input value as zero by force, zero point error can be adjusted with 3 ways as below. When zero point adjustment with front key and Hold terminal is finished normally, zero point of measurement terminal is displayed and the adjusted value at saved in  $inbL$  automatically.

Operation	Input correction value	Front panel key	External input signal
Description	PA 1: Direct input correction value method at $inbL$ mode.	Press both $\left[ \left[ \left[ \right] \right] \right]$ keys for 3 sec. at the measuring mode.	Short-circuit external Hold terminal 11,12 [6, 7 (MT4W)] over min. 50m. ※It is enable to use in option mode.

※Refer to "◎ Error correction function", "◎ Error display function" and "■ Parameter 2" for function and error.

### ◎ Current output (DC4-20mA) scale function [PA2 group: $F5-H / F5-L$ ]

It sets current output for the display value at the output current DC 4-20mA.

It sets display value for 4mA at  $F5-L$  and 20mA at  $F5-H$  and the range between  $F5-H$  and  $F5-L$  should be 10%

※When min. set interval between  $F5-H$  and  $F5-L$  is set as under 10% F.S., it changed as over 10% F.S. automatically.)

※Preset display value is fixed to output as 4mA at under  $F5-L$  and 20mA at over  $F5-H$ .

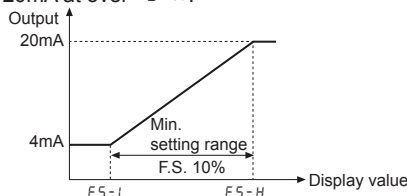

### ◎ Initialization function

It initializes as the factory default status. If press  $\left[ \left[ \left[ \right] \right] \right]$  keys together for 2sec. in RUN mode,  $inLk$  mode and the setting value ( $n0$ ) is displayed every 0.5 sec. and it will be initialized as the factory default when press  $\left[ \text{MODE} \right]$  key after

change  $n0 \rightarrow 4E5$ .

### ◎ Startup compensation time function [PA 2 group: $5ERL$ ]

This time function limits the operation of an output until the measured input (overvoltage or inrush current) is stable at moment of power on. All outputs are off during startup compensation time setting after power is applied.

Setting range: 00.0 to 99.9 (unit: sec.)

Factory default: 00.0

### ◎ Error display function

Display	Description
HHHH	Flashes when measuring input is exceeded the max. allowable input (110%)
LLLL	Flashes when measuring input is exceeded the minx. allowable input (-10%)
d-HH	Lights when display input is exceeded the max. display range (9999) or H-5C setting value
d-LL	Lights when display input is exceeded the min. display range (-1999) or L-5C setting value
F-HH	Flashes when measuring frequency is exceeded themax. measuring value (9999)
00Er	Flashes when it exceeds zero adjustment range ( $\pm 99$ )

※Error display is released automatically when it is in the measured and display range.

※"LLLL" is displayed when the measuring input is 4-20mA.

※ After flashing "00Er" 2 times when it exceeds the zero range, it returns to RUN mode.

### ◎ Display scale function[PA 1 group: $H-5C / L-5C$ ]

This function is to display setting (-1999 to 9999) of particular High/Low-limit value in order to display High/Low-limit value of measured input. If measured inputs are 'a' and 'b' and particular values are 'A' and 'B', it will display  $a=A$ ,  $b=B$  as below graphs.

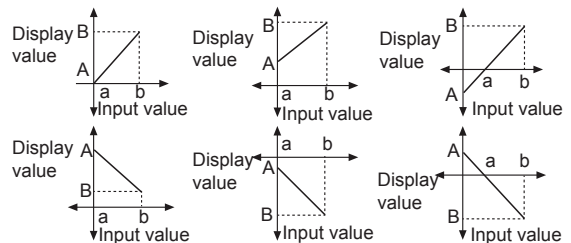

### ◎ Gradient correction function [PA 1 group: $inbH$ ]

This function is to correct a gradient of prescale value and display value. (Fig.1) Display value Y can be used as  $\alpha$ ,  $\beta$  times against X input value by correction function[ $inbH$ ]. And also can be used as correction function of max. display value (H-5C). Adjustment range is 0.100 to 5.000 and multiply current gradient.

E.g.) Input: DC200mV, Display: 3.000 for MT4W-DV

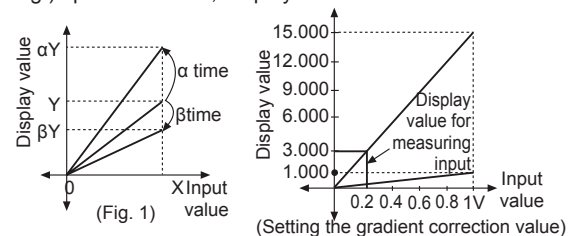

(A) Photoelectric Sensors
(B) Fiber Optic Sensors
(C) Door/Area Sensors
(D) Proximity Sensors
(E) Pressure Sensors
(F) Rotary Encoders
(G) Connectors/ Sockets
(H) Temperature Controllers
(I) SSRs / Power Controllers
(J) Counters
(K) Timers
(L) Panel Meters
(M) Tacho / Speed / Pulse Meters
(N) Display Units
(O) Sensor Controllers
(P) Switching Mode Power Supplies
(Q) Stepper Motors & Drivers & Controllers
(R) Graphic/ Logic Panels
(S) Field Network Devices
(T) Software

# MT4Y/MT4W Series

- ① Select 0-1VDC for measuring input in Parameter1.
- ② Standard specification in input: 0-1VDC and 1.000 therefore it has to be 15.000 ( $H-5C$ ) for 1VDC (input) in order to display 3.000 for DC200mV (input). But it is disable due to setting range is 9.999
- ③ In this case, please check below chart.  
Please set as  $i_{nbH} \times H-5C = 15.000$

Setting	$H-5C$	$L-5C$	$i_{nbH}$	Other
①	Disable	0.000	1.000	—
②	7.500	0.000	2.000	It will be the same display value.
③	5.000	0.000	3.000	
④	3.750	0.000	4.000	
⑤	3.000	0.000	5.000	

## ◎ Error correction function [PA 1 group: $i_{nbH}$ / $i_{nbL}$ ]

It corrects display value error of measured input.

$i_{nbL}$ :  $\pm 99$  (Adjust deviation of low value)

$i_{nbH}$ : 5.000 to 0.100 [Correct gradient (%) of high value]

Display value = (Measured value  $\times i_{nbH}$ ) +  $i_{nbL}$

E.g.) Low value correction

When there is an application where there is a residual voltage of 1.2V, but a 0V display is desired, then it is possible by adjusting the  $i_{nbL}$  parameter setting to 12 (offset correcting value or equal to 1.2V without decimal) that the desired display value of 0 can be achieved.

E.g.) High value correction

When there is an application where the high actual value of display is 501 and exceeds the 500V display range, then it is possible by adjusting the  $i_{nbH}$  parameter setting to 0.998 (calculated by desired value of 500/actual value of 501), that the desired value can be achieved.

※ The offset correction range of  $i_{nbL}$  is within -99 to 99 for D-0, D-1 digit regardless of decimal point.

## ◎ Display cycle delay function [PA 2 group: $d15t$ ]

In some applications the measured input may fluctuate which in turn causes the display to fluctuate. By adjusting the display cycle delay function time in the  $d15t$  mode in parameter 2, the operator can adjust the display time within a range of 0.1 sec to 5 sec. For example, if the operator sets the display cycle time to 4.0 sec., the display value displayed will be the average input value over 4 sec. and also will show any changes if any every 4 sec.

## ◎ Monitoring peak display value function [PA 0 group: $HPEL$ / $LPEL$ , PA 2 group: $PEEL$ ]

It monitors max./min. value of display value based on the current displays value and then displays the data at  $HPEL$ ,  $LPEL$  of parameter 0. Set the delay time (0 to 30 sec.) at  $PEEL$  of parameter 2 in order to prevent malfunction caused by initial overcurrent or overvoltage, when monitoring the peak value. Delay time is 0 to 30 sec. and it starts to monitor the peak value after the set time.

When pressing any one of  $\left[ \leftarrow \right]$   $\left[ \rightarrow \right]$  keys at  $HPEL$ ,  $LPEL$  of parameter 0, the monitored data is initialized.

※  $HPEL$ ,  $LPEL$  parameters is not displayed when monitoring delay time [ $PEEL$ ] of parameter 2 group is set as 00 sec. [00 5].

## ◎ Preset output Mode [PA 2 group: $oUt.t$ mode]

Mode	Output operation	Operation
$oFF$		No output
$L5t$		If it is equal or smaller than low setting value, LO output will be ON. If it is bigger than low setting value, GO output will be ON.
$H5t$		If it is equal or bigger than high setting value, HI output will be ON. If it is equal or smaller than high setting value, GO output will be ON.
$LH5t$		If it is equal or smaller than low setting value and equal or bigger than high setting value, the output will be ON. If it is bigger than Low setting value and smaller than high setting value, GO output will be ON.
$HH5t$		If it is equal or bigger than low set and equal or bigger than high set value, output will be ON. If it is smaller than low setting value and high setting value, GO output will be ON.
$LHL5t$		If it is equal or smaller than low setting value, LO output will be ON. If it is equal or smaller than high setting value, HI output will be ON. If it is bigger than low setting value and High setting value, GO output will be ON.
$Ld5t$		This operation is the same as $L5t$ . But it doesn't operate at initial low set value, it will operate at next low set value. If this is higher than low set value, Go output will be ON.

※ "H" means hysteresis and able to set 1 to 99 at "H55" mode in para-meter 2 among above comparison output chart.

※ Only  $L5t$  setting is available in MT4Y-□-43 and MT4Y-□-44 models.

## ◎ Sub output (Transmission function)

### • RS485 communication output

It is able to set address (01 to 99)

It is able to transmit by selecting modulation speed (Transmitted number of signal per 1sec.) of serial transmission. (Selectable 1200, 2400, 4800, 9600bps)

### • Low-speed serial output

It outputs current display value as Low-frequency (50Hz) type.

### • Current output (DC4-20mA)

It outputs DC4-20mA against High/Low-limit scale. (Resolution: 12000 division)

### • BCD output

It outputs display value as BCD Code..

※ Only one sub-output is selectable.

(More than one sub-output is not allowed.)

## © Time chart of BCD output and Serial output

- BCD output (Negative logic)

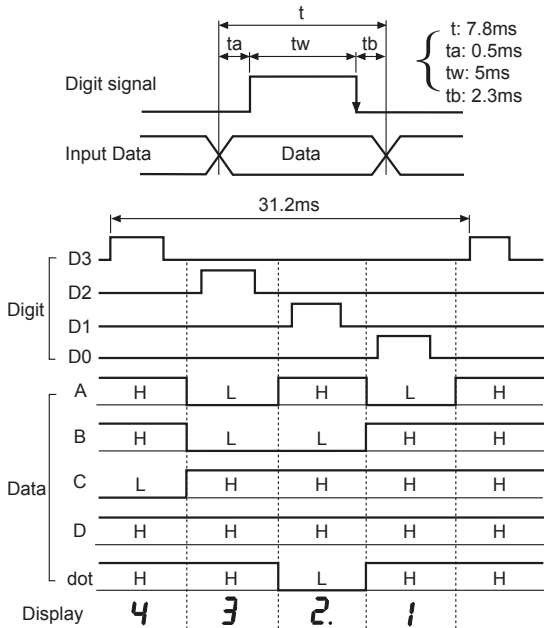

- Serial output (Negative logic)-Clock frequency:50Hz

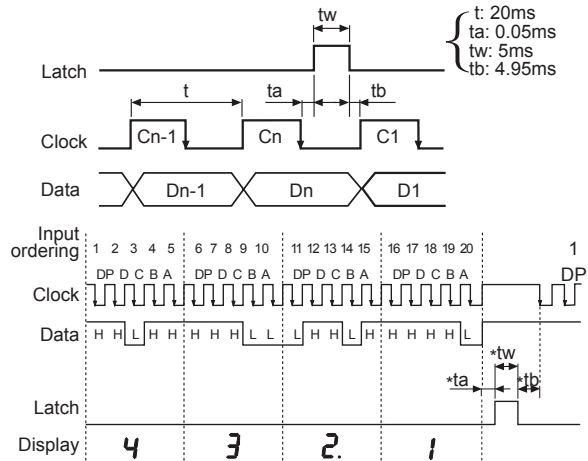

(A)	Photoelectric Sensors
(B)	Fiber Optic Sensors
(C)	Door/Area Sensors
(D)	Proximity Sensors
(E)	Pressure Sensors
(F)	Rotary Encoders
(G)	Connectors/ Sockets
(H)	Temperature Controllers
(I)	SSRs / Power Controllers
(J)	Counters
(K)	Timers
(L)	Panel Meters
(M)	Tacho / Speed / Pulse Meters
(N)	Display Units
(O)	Sensor Controllers
(P)	Switching Mode Power Supplies
(Q)	Stepper Motors & Drivers & Controllers
(R)	Graphic/ Logic Panels
(S)	Field Network Devices
(T)	Software